

Home Theater Master Universal Remote Control



**SL-8000
Operating
Manual**

Table of Contents

	Page
Introduction	2
Battery Installation	3
A. To Open and Close Battery Compartment Cover	3
B. Low Battery Message	3
Using Your Remote Control	4
A. Function Table Reference	4
Function Tables	5
B. Preprogrammed Set Up	8
Three Digit Code Method	8
Auto Search Method	10
Recalling the Set Up Code Number	12
C. Operation	13
Device Buttons	14
Main Device Mode	15
Automatic Audio Mode	15
Backlighting	16
Advanced Features	17
A. Punch Through Controls	17
Volume “Punch Through”	17
Channel “Punch Through”	18
Transport “Punch Through”	20
B. Memory Buttons	22
Programming Memory Buttons	24
Erasing Memory Buttons	25
C. Changing the LCD Display	26
D. Programming a Second TV, VCR, etc. to other Device Buttons	27
Warranty and Specifications	29
Glossary	30
Appendix	32
Assignment of Audio/Video Equipment	32
Set Up Code Tables	33
Audio	33
Satellite	36
TV	38
VCR	41
Cable	44
CD	46
DVD	48
AUX	49

Introduction

The **Home Theater Master SL-8000** remote control is preprogrammed to operate over 1,000 Audio and Video components so that you can set it up by simply punching in a three digit code number that matches your equipment.

The **Home Theater Master SL-8000** remote control operates up to **eight** different audio and video devices in your home entertainment system. They are listed below:

- 1 TVs, Monitors, Video/LCD Projectors**
- 2 VCRs, TV/VCR combination units**
- 3 Cable boxes, Internet set-tops**
- 4 Satellite receivers - DSS, Primestar, Dish, DBS, C-Band**
- 5 Audio receivers, Preamplifiers, Surround processors**
- 6 Compact disc players, Multi-Disc changers**
- 7 DVD, Laser disc players, Cassette decks**
- 8 Cassette Tape Players, DAT, MiniDisc, Switchers, Lighting, Home Control Devices, and Line Doublers**

Setting up the remote control to work with your equipment is simple. The remote control also has many advanced features that can add ease and enjoyment to the operation of your home entertainment system. Please follow the instructions in this manual, and retain the manual for future reference.

For any questions or comments about this remote control, please contact Universal Remote Control, Inc., 271 North Avenue, New Rochelle, NY 10801, or call (914) 235-2610. Service hours are 9:00 AM to 6:00 PM EST, Monday- Friday.

Battery Installation

This remote control uses four AAA 1.5 V batteries. Please be sure to match the batteries with the (+) and (-) markings inside the battery compartment during installation.

A: To Open and Close the Battery Compartment Cover

- 1** To open the battery cover, push the latch forward toward the top of the remote control, and lift the latch up.
- 2** To close the battery cover, slide the battery cover straight back in (toward the top of the remote) and push down until it “clicks” into place.

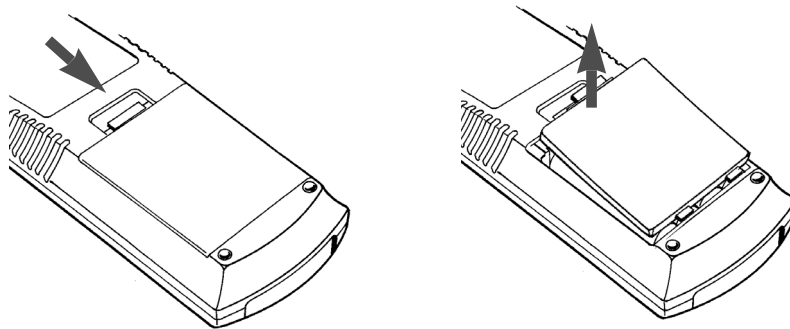

B: Low Battery Message

When the Liquid Crystal Display (LCD) flashes L_BAT, the batteries should be replaced.

Note: Batteries should last about 6 months under normal conditions. The *SL-8000* remote control will retain its programmed memory for up to one year after the batteries are removed and up to ten years after the batteries go “dead”.

Using Your Remote

A: Function Table Reference

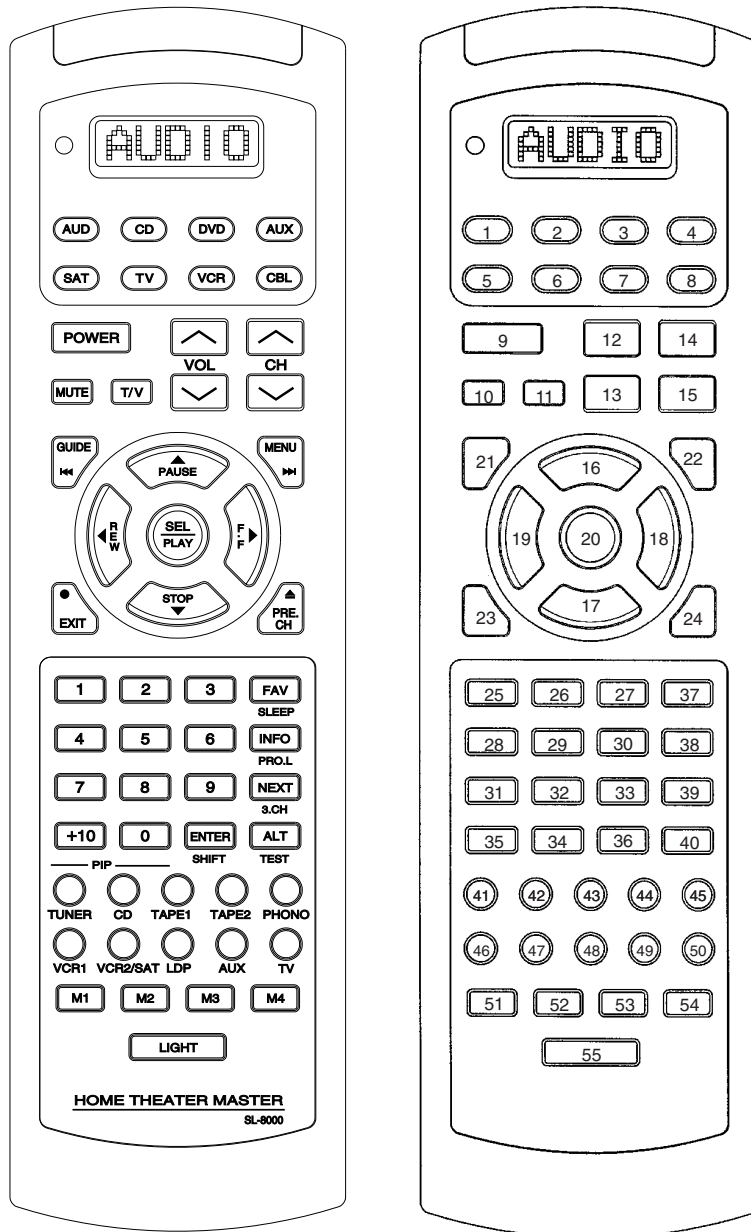

Using Your Remote

Function Table

No.	Button Name	Audio Functions	SAT Functions	TV Functions
1-8	Device Name	AUDIO (ON)	SAT (ON)	TV (ON)
9	Power	On/Off (OFF)	On/Off (OFF)	On/Off (OFF)
10	Mute	Mute	Mute	Mute
11	T/V Input	Band/FM	TV/SAT	TV/Video
12	VOL Up	Vol Up	Vol Up	Vol Up
13	VOL Down	Vol Down	Vol Down	Vol Down
14	CH Up	Preset +	Ch. Up	Ch. Up
15	CH Down	Preset -	Ch. Down	Ch. Down
16	Up/Pause	Center +	Up	Up
17	Down/Stop	Center -	Down	Down
18	Right/F.F.	Rear +	Right	Right/Picture
19	Left/Rew	Rear -	Left	Left/Audio
20	Sel/Play	Select/Sub.Bass	Select	Select/Enter
21	Guide/I<<	Display	Guide	Display/Recall
22	Menu/>>I	Surround	Menu	Menu
23	Exit/Rec	Delay -	Exit/Cancel	Exit/Clear
24	Pre. Ch./Eject	Delay+	Prev. Ch.	Q. View/Last Ch.
25-34	1—0	1—0	1—0	1—0
35	10+	Plus 10		100/Ch. Scan
36	Enter/Shift	Shift	Enter	Ch. Scan
37	Fav/Sleep	Sleep	Fav	Sleep
38	Info/Pro. L.	Pro. Logic	Info/Fetch	Caption
39	Next/3 Ch.	3 Ch.	Next Prog.	Ant
40	Alt/Test	Test Tone	Alt. Audio	Reset
41	Tuner	Tuner/AM/FM		PIP On/Auto Ch.
42	CD	CD		PIP Swap, Add
43	Tape 1	Tape 1		PIP Freeze/Delete
44	Tape 2	Tape 2		PIP Off/Position
45	Phono	Phono		TV/CATV
46	VCR1	VCR1	Rec.	Auto
47	VCR2/SAT	VCR2		Add
48	LD/DVD	LD/DVD		Delete
49	Aux	Aux		
50	TV	TV		
51	M1			
52	M2			
53	M3			
54	M4			
55	Light			

Using Your Remote

Function Table

No.	Button Name	VCR Functions	Cable Functions
1-8	Device Name	VCR (ON)	CABLE (ON)
9	Power	On/Off (OFF)	On/Off (OFF)
10	Mute	Mute	Mute
11	T/V Input	VCR/TV	Switch/A/B
12	VOL Up	Vol Up	Vol Up
13	VOL Down	Vol Down	Vol Down
14	CH Up	Ch Up	Ch Up
15	CH Down	Ch Down	Ch Down
16	Up/Pause	Pause	Up/Fine +
17	Down/Stop	Stop	Down/Fine -
18	Right/F.F.	Fast Forward	Right/Fine R
19	Left/Rew	Rewind	Left/Fine L
20	Sel/Play	Play	Select
21	Guide/I<<	F. Adv./Slow<	Guide/Recall
22	Menu/>>I	X2/Intro/Slow>	Menu
23	Exit/Rec	Record	Exit
24	Pre. Ch./Eject	Eject	Prev. Ch
25-34	1—0	1—0	1—0
35	10+	1—100	*/Help
36	Enter/Shift	Enter	Enter/Memory
37	Fav/Sleep	Program	Fav
38	Info/Pro. L.	Display	Info
39	Next/3 Ch.	C-Counter	PPV/Buy
40	Alt/Test	Reset	P/Delete
41	Tuner	Auto Ch	Page -
42	CD	Add +	Page +
43	Tape 1	Delete -	Day -
44	Tape 2	Tape Speed	Day +
45	Phono	VCR Plus	Record
46	VCR1	Tracking +	
47	VCR2/SAT	Tracking -	
48	LD/DVD	Auto Tracking	
49	Aux	Slow -	
50	TV	Slow +	
51	M1	Index	
52	M2	QTR On	
53	M3	QTR Off	
54	M4	Edit	
55	Light		

Using Your Remote

Function Table

No.	Button Name	CD Functions	DVD Functions	AUX Functions
1-8	Device Name	CD (ON)	DVD (ON)	TAPE (ON)
9	Power	On/Off (OFF)	On/Off (OFF)	On/Off (OFF)
10	Mute	Mute/Fader		Mute/Rec Mute
11	T/V Input	Random		
12	VOL Up	Vol Up		
13	VOL Down	Vol Down		
14	CH Up	Track +/Skip +	Skip >>I	
15	CH Down	Track-/Skip -	Skip I<<	
16	Up/Pause	Pause	Pause	Pause
17	Down/Stop	Stop	Stop	Stop
18	Right/FF.	FF/Search +	FF.	FF.
19	Left/Rew	REW/Search -	REW	REW
20	Sel/Play	Play	Play	Play
21	Guide/I<<	Search -	Set Up	Deck A
22	Menu/>>I	Search +	Menu	Deck B
23	Exit/Rec		Clear	Record
24	Pre. Ch./Eject	Eject/Intro	Open/Close	Rev. Play
25-34	1—0	1—0	1—0	
35	10+	Plus 10	10+	Deck A
36	Enter/Shift	Disc	Enter	Deck B
37	Fav/Sleep	Program	Return	
38	Info/Pro. L.	Display	Display	
39	Next/3 Ch.	Repeat	Sub. On/Off	
40	Alt/Test	Clear	Audio	
41	Tuner	Disc 1	Up	REW
42	CD	Disc 2	Down	For. Play
43	Tape 1	Disc 3	Select	FF.
44	Tape 2	Disc 4	Angle	Stop
45	Phono	Disc 5	Slow	REV. Play
46	VCR1	A-B	Left	Pause
47	VCR2/SAT	Time	Right	Record
48	LD/DVD	Intro	Subtitle	
49	Aux	Edit	Repeat	
50	TV		Random	
51	M1		A/B Repeat	
52	M2		T	
53	M3		Title	
54	M4		Memory	
55	Light			

Using Your Remote

B: Preprogrammed Set Up

The *Home Theater Master* universal remote control can operate up to eight separate audio and video devices (**equipment**). To program the remote control for your devices, please use the following steps:

Three Digit Code Method

- 1 Turn on the device you would like the remote control to operate, either manually or with your original remote control.
- 2 Find the three digit *Set-Up Code* number for your device from the tables on pages (33~50).

Example: To set up the remote to operate with a ZENITH TV, go to the TV Set-Up Code table found on pages (38 - 40) and look for ZENITH under the Manufacturer/Brand column. You will find that the Set-Up Code numbers for ZENITH TVs are 072, 073, 095, 103 and 157.

- 3 Press the corresponding *Device Button* (TV, VCR, SAT, CBL, AUD, CD, DVD, or AUX) and the *MUTE* button on the remote control simultaneously. **SET** will appear in the LCD.

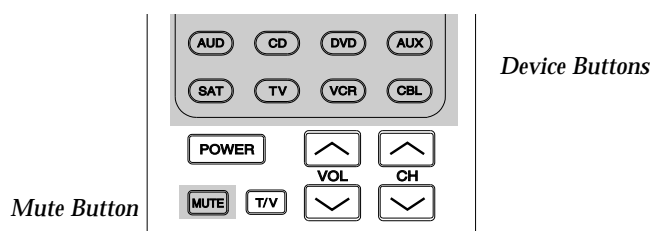

Example: To set-up the remote to operate a TV, press the TV *Device Button* and the *Mute* button, simultaneously.

Using Your Remote

Note: *SET* appears in the LCD for 20 seconds to indicate that the remote control is ready to be programmed. The following steps must be entered while *SET* appears in the LCD.

- 4 Point the remote control toward the device that was turned on in Step 1 and press in the first three-digit *Set-Up Code* number for that device using the number buttons (0-9) on the remote control. *SET* followed by the number will appear in the LCD.

Your device will turn off when the correct *Set-Up Code* number has been selected. If the device does not turn off, press in the next *Set-Up Code* number from the listing. Continue to select *Set-Up Code* numbers until your device turns off, before you proceed to Step 5.

Note: *If you have tried all of the three digit Set-Up Code numbers listed for your device and it still did not turn off, please proceed to the Auto Search Method on page (10) to program your remote control.*

- 5 Once your device turns off, press the *Device Button* selected in Step 3 once again to store the *Set-Up Code* number. *PASS* will flash in the LCD.
- 6 Test the remote control for your device. Try the *POWER*, *CHANNEL UP AND DOWN*, *VOLUME UP AND DOWN* buttons, etc. If any of the buttons do not perform as they should, please repeat the set-up from Step 1 using the next *Set-Up Code* number for your device.

Note: *Some audio/video devices have separate buttons for POWER ON and POWER OFF. To operate these devices on the remote, press the corresponding DEVICE Button to turn the equipment ON and press the POWER button to turn the equipment OFF.*

- 7 Please repeat the above steps to program the remote control for each of your other devices.

Using Your Remote

Auto Search Method

Please use this method if none of the *Set-Up Code* numbers worked for your device during the standard set-up procedure or if the manufacturer or brand for your device is not listed in *Set-Up Code Tables*.

- 1 Turn on the device you would like the remote control to operate, either manually or with your original remote control.
- 2 Press the corresponding *Device Button* (TV, VCR, SAT, CBL, AUD, CD, DVD, or AUX) and the *MUTE* button, simultaneously. **SET** will appear in the LCD.

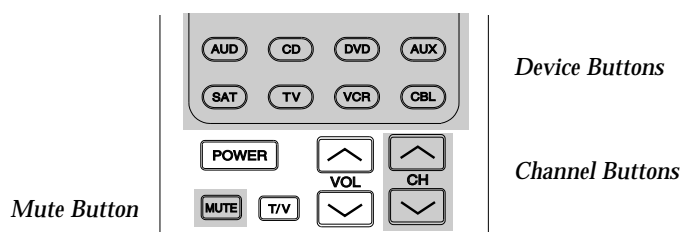

Note: **SET** appears in the LCD for 20 seconds to indicate that the remote control is ready to be programmed. The following steps must be entered while **SET** appears in the LCD.

- 3 Point the remote control toward the device and press the *CHANNEL UP* button on the remote control. Each button press sends the signal for one *Set-Up Code* number. Keeping the *CHANNEL UP* button pressed produces a quick scanning of the *Set-Up Code* numbers. Release the *CHANNEL UP* button as soon as the device turns off. Please confirm that you have the correct code by pressing the *MUTE* button on the remote. You should be able to turn your device on and off with this button.

Using Your Remote

If you pass the correct *Set-Up Code* number, you can return to it by pressing the **CHANNEL DOWN** button, one *Set-Up Code* number at a time, until your device turns back on.

Note: During programming, the signal for **POWER ON** and **POWER OFF** is located on the **MUTE** button. For devices that use separate **POWER ON** and **POWER OFF** buttons, pressing the **MUTE** button on the remote control during programming will only turn the device **OFF**.

4 Once the correct code is confirmed, press the *Device Button* to store the *Set-Up Code* number. **PASS** will appear in the LCD.

5 Test the remote control for your device. Try the **POWER**, **CHANNEL UP AND DOWN**, **VOLUME UP AND DOWN** buttons, etc. If any of the buttons do not perform as they should, please repeat the set-up from Step 1 using the next *Set-Up Code* number for your device.

Note: Some audio/video devices have separate buttons for **POWER ON** and **POWER OFF**. To operate these devices on the remote, press the corresponding **DEVICE Button** to turn the equipment **ON** and press the **POWER** button to turn the equipment **OFF**.

6 Please repeat the above steps to program the remote control for each of your other devices.

Using Your Remote

Recalling the Set-Up Code Number

To display the three digit *Set-Up Code* number that was stored for a device.

- 1** Press the *Device Button* and the *MUTE* button, simultaneously. **SET** will appear in the LCD.
- 2** Press the *T/V* button. The LCD will quickly flash the three digit *Set-Up Code* number that was stored for your device in that mode.
- 3** Please write your *Set-Up Code* numbers in the chart below, for future reference.

Set-Up Code Numbers:

Audio	<input type="text"/>	<input type="text"/>	<input type="text"/>	Cable	<input type="text"/>	<input type="text"/>	<input type="text"/>
SAT	<input type="text"/>	<input type="text"/>	<input type="text"/>	CD	<input type="text"/>	<input type="text"/>	<input type="text"/>
TV	<input type="text"/>	<input type="text"/>	<input type="text"/>	DVD	<input type="text"/>	<input type="text"/>	<input type="text"/>
VCR	<input type="text"/>	<input type="text"/>	<input type="text"/>	AUX	<input type="text"/>	<input type="text"/>	<input type="text"/>

Using Your Remote

C: Operation

After you have programmed the remote control for your equipment, use the following procedures to operate your home entertainment system:

- 1** Press the *Device Button* that you wish to operate: e.g. to operate a TV, press the *TV Device Button*; to operate a VCR, press the *VCR Device Button*, etc.
- 2** Aim the remote control at the device and press the *POWER* button to turn on the device.
- 3** Press the buttons that send out the commands you desire.

Note: *Some audio/video devices have separate buttons for **POWER ON** and **POWER OFF**. To operate these devices on the remote, press the corresponding **DEVICE Button** to turn the equipment **ON** and press the **POWER** button to turn the equipment **OFF**.*

Please try all the functions of this remote control with your equipment. The most common functions are labeled on the remote. However, some of the secondary functions might be stored under a button that has a different name from the one on your original remote control. Please refer to the Function Tables on pages (5 - 7) for details.

Using Your Remote

Device Buttons

Any press of a *Device button* at the top of the remote control can perform the following functions:

- 1 Changes the *Device mode* on the SL-8000 remote control.
- 2 Sends out a preprogrammed POWER ON command for a Device, if applicable.
- 3 Sends out a *joined* selection.
- 4 Toggles between the Main Device mode and the Automatic Audio mode if the Automatic Audio Mode is active.

Joining to Device Buttons

The 10 preprogrammed Audio input selects and the keypad buttons 0-9 found on the SL-8000 in the *AUDIO Device* mode can be *joined* to individual *Device buttons*. Once joined, any press of the *Device button* will also emit the *joined* command.

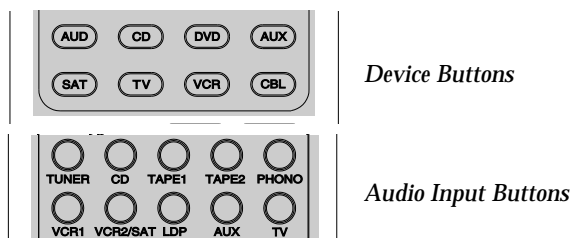

Setting Up:

- 1 Press the AUDIO and ENTER buttons simultaneously on the remote control. **JOIN** will appear in the LCD.
- 2 Press the *Device button* that you would like to assign a joined function. **CLEAR** will flash and **INPUT** will then appear in the LCD.
- 3 Select a button to be *joined* from the remote control, e.g., VCR1, VCR2, CD, etc. or 1, 1, 2 etc.). The LCD will display **IN_XX** indicating the Audio input selected (IN_V1, IN_V2, IN_CD, etc. or IN_0, IN_1, IN_2 etc.) and then **JOIN**.

Appendix

A: Assignment of Audio/Video Equipment

Please use the following listing to locate the correct *Set-Up Code Tables* for your equipment:

AUDIO Set-Up Code Table:

Audio Receivers, Preamplifiers, Surround Processors

Satellite Set-Up Code Table:

DSS, Primestar, DBS, Echostar, C Band receivers

TV Set-Up Code Table:

TVs, Monitors, Video/LCD Projectors

VCR Set-Up Code Table:

VCRs, TV/VCR combination units

CABLE Set-Up Code Table:

Cable Boxes, Internet/TV Set-Tops

CD Set-Up Code Table:

CD Players, CD Changers

DVD Set-Up Code Table:

DVD Players, Laser Disc

AUX Set-Up Code Table:

Cassette Tape Players, DAT systems, MiniDisc, Switchers, Lighting, Home Control Devices, and Line Doublers

Glossary

Punch Through

Advanced feature that enables you to operate Volume, Channel or Transport Control functions of one device while in another mode.

Example: Audio Volume Control “Punch Through” gives you the ability to raise, lower and mute your Audio receiver volume while operating the remote control in the TV mode.

Set-Up Code Number

The three-digit number that is used to program the remote control for your particular manufacturer or brand of audio/video equipment. *Set-Up Code* numbers are located in tables in the appendix on pages 33 - 50 of the instruction manual. *Set-Up Code* numbers are categorized by type of device, e.g. TV, VCR, Audio, CD, DVD, Cable, AUX and Satellite.

More than one *Set-Up Code* number may work with your device. You should test the functions for each of the *Set-Up Code* numbers that work with your device to determine the best *Set-Up Code* number for your particular device.

Note: *Some devices, such as CD players and DVD Decks that do not have POWER buttons on their original remote controls, may not shut off during programming. For these devices, it may be necessary to first store the Set-Up Code number and then test functions like PLAY, STOP, etc., to determine if the correct Set-Up Code number has been selected.*

Transport Control

Buttons that correspond to the PLAY, STOP, REWIND, FAST FORWARD, PAUSE, SEARCH/SKIP and RECORD functions on your audio/video equipment.

Using Your Remote

- 4 Press the ENTER button. **SAVE** will flash twice and the LCD will return to **AUDIO** indicating that the *joined* function has been stored.

Every time that the *Device button* is pressed it will also emit the *joined* function.

To erase a *joined* function from a *Device button*:

- 1 Press the AUDIO and ENTER buttons simultaneously on the remote control. **JOIN** will appear in the LCD.
- 2 Press the *Device button* that you would like to erase a *joined* function. **CLEAR** will flash and **INPUT** will then appear in the LCD.
- 3 Press the ENTER button. The LCD will flash **SAVE** twice and return to **AUDIO** indicating that the *join* has been erased.

Main Device Mode

When the main device is displayed in the LCD, the SL-8000 will perform all of the preprogrammed, joined and punch through features for that device mode.

Automatic Audio Mode

The remote is defaulted to the Automatic Audio. When the remote control is in this mode, pressing a *Device button* a second time will display **A_XXX** in the LCD indicating that the Volume and Mute controls of the device programmed into the Audio mode of the SL-8000 is active, while full function control of all other buttons of the current *Device mode* is maintained.



Advanced Features

After you set-up the remote control to operate your equipment, you can also program advanced features on the remote control. The advanced features are designed to enhance the use of the remote control with your home entertainment system.

A: Punch Throughs

Volume Control "Punch Through"

You can program the remote control so that either the *AUDIO* or *TV Volume Control (VOLUME UP, DOWN AND MUTE)* will also operate in other modes on the remote control.

Example: Raise, lower and mute the *VOLUME* of your Audio receiver while the remote control is in the Satellite mode.

Note: When this feature is active, the *AUDIO* or *TV VOLUME* and *MUTE* will override any existing volume controls in that mode.

To Set-Up:

- 1** Select the mode that you wish to program for *Volume Control "Punch Through."*
- 2** Press the corresponding *Device Button* and the *MUTE* button simultaneously. **SET** will appear in the LCD.
- 3** Press the *VOLUME UP* button. **PUNCH** will appear in the LCD.
- 4** Press either the *AUDIO Device Button* to set-up for *Audio Volume Control* or the *TV Device Button* to set-up for *TV Volume Control*. **AUDIO** or **TV** will flash in the LCD, depending on which *Device Button* was selected.
AUDIO or *TV Volume Control* will now override the original *VOLUME* and *MUTE* in this mode.

Glossary

Cursor Control

Buttons that correspond to the UP, DOWN, LEFT, RIGHT, SELECT, GUIDE, MENU and EXIT functions of your audio/video equipment.

Device

Audio or video equipment, e.g. Television, VCR, Cable box, Audio receiver, Satellite receiver, etc.

Device Button

Any of the eight buttons located at the top of the remote control labeled AUD, CD, DVD, AUX, SAT, TV, VCR and CBL. *Device Buttons* are used to select modes of operation and to program the remote control.

Joining

Transfer of a function from the AUDIO input selects and keypad(0-9) on the SL-8000 to a Device button at the top of the remote control.

LCD

Liquid crystal display window located at the top of the remote control. During normal operation the LCD indicates the mode. The LCD also indicates the remote's programming status.

Memory Buttons

Buttons labeled M1, M2, M3, M4, and POWER. These buttons can be programmed to store Favorite Channels, Macro Commands, or to "relocate" functions from one mode to another.

Modes

Modes correspond to *Device Button* selections. Modes are displayed in the LCD as AUDIO, CD, DVD, AUX, SAT, TV, VCR and CABLE. Modes indicate the type of device the remote control is currently operating.

Warranty

The **Home Theater Master SL-8000** remote control comes with a one-year warranty from the date of purchase.

Specifications

Model

SL-8000, infrared remote control.

Power

Four 1.5 V AAA Batteries.

Dimensions (h/w/d)

8.88 x 2.5 x 1.25 inches

Weight

6.5 oz. (with batteries)

Advanced Features

To Return to the Original Setting:

- 1** Select the mode that you want to turn off the *Volume Control "Punch Through."*
- 2** Press the corresponding *Device Button* and the *MUTE* button simultaneously. **SET** will appear in the LCD.
- 3** Press the *VOLUME UP* button. **PUNCH** will appear in the LCD.
- 4** Press the *Device Button* again. The **DEVICE Mode** will flash in the LCD.

The *AUDIO or TV Volume Control "Punch Through"* is now turned off. The *VOLUME* and *MUTE* of the original device will operate on the remote control.

Channel Control "Punch Through"

You can program the remote so that either the *SAT or Cable Channel Controls (CHANNEL UP and DOWN)* will also operate in other modes on the remote control.

Example: Change *CHANNELS UP and DOWN* on your cable box while the remote is in the TV mode.

Note: When this feature is active, **SAT or Cable CHANNEL UP and DOWN** will override any existing channel controls in that mode.

To Set-Up:

- 1** Select the mode that you wish to program for *Channel Control "Punch Through."*
- 2** Press the corresponding *Device Button* and the *MUTE* button simultaneously. **SET** will appear in the LCD.
- 3** Press the *VOLUME DOWN* button. **PUNCH** will appear in the LCD.

Advanced Features

- 4** Press either the *SAT Device Button* to set-up for *SAT Channel Control* or the *CBL Device Button* to set-up for *Cable Channel Control*. Either **SAT** or **CBL** will flash in the LCD, depending on the *Device Button* selected.

SAT or Cable Channel Controls will now override the original CHANNEL UP and DOWN in this mode.

To Return to the Original Setting:

- 1** Select the mode that you want to turn off the *Channel Control "Punch Through."*
- 2** Press the corresponding *Device Button* and the *MUTE* button, simultaneously. **SET** will appear in the LCD.
- 3** Press the *VOLUME DOWN* button. **PUNCH** will appear in the LCD.
- 4** Press the same *Device Button* again. The **DEVICE Mode** will flash in the LCD.

The SAT or Cable Channel Control "Punch Through" is now turned off. The CHANNEL UP and DOWN of the original device will now operate on the remote control.

Advanced Features

Your device will turn off when the correct *Set-Up Code* number has been selected. If it does not turn off, select the next *Set-Up Code* number from the table, and press in that code number. When your device turns off, proceed to Step 6.

6 Press the *Device Button* that was selected in Step 2. to store the *Set-Up Code* number. **PASS** will flash in the LCD to confirm the programming.

The second device can now be operated by pressing the assigned *Device Button* and using the buttons within this mode.

Advanced Features

LCD Displays in the Automatic Audio Mode

A_TV	A_VCR	A_CAB	A_SAT	AUDIO	A_CD
A_DVD	A_AUX	A_TV2	A_VC2	A_TUN	A_AM1
A_AM2	A_TA1	A_TA2	A_WEB	A_SUR	A_DAT
A_PRJ	A_AX2	A_LD	A_A2	A_LIT	A_DSS
A_AV	A_TAP	A_DAB			

D: Programming a Second TV, VCR, etc. to Other Device Buttons.

This feature is used to program the remote control for two or more TVs, VCRs, etc., or to program a device into a mode with a different *Device Button* name. You can store the three-digit *Set-Up Code* number for any device into any other unused *Device Button*.

Example: If your home entertainment system contains two VCRs. First, using the *VCR Device* button, program the remote via standard set-up to operate the first VCR. Then, program your second VCR into a *Device Button* that is not being used, e.g., *AUX* using this method.

- 1 Turn on the device.
- 2 On the remote control, press the *Device Button* that you will assign for the device and the *MUTE* button, simultaneously. **SET** will appear in the LCD.
- 3 Press the *Device Button* that corresponds to the original device. **SET** will still appear in the LCD.
- 4 Locate the *Set-Up Code* number for the device from the tables found on pages (33 - 50).
- 5 Point the remote toward the device and press in the first *Set-Up Code* number. **SET**, followed by the *Set-Up Code* number will appear in the LCD.

Advanced Features

Transport Control “Punch Through”

You can set-up your remote control so that *VCR or CD Transport Controls (PLAY, STOP, FAST FORWARD, REWIND, PAUSE, and RECORD)* will also operate in other modes on the remote control.

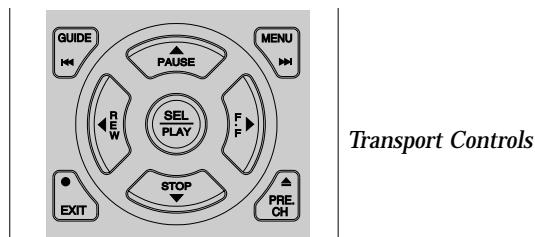

Example: Control VCR functions while operating the remote control in the TV mode.

Note: When this feature is active, the *VCR or CD functions (PLAY, STOP, FAST FORWARD, REWIND, PAUSE, and RECORD)* will override any existing functions pre-assigned to these buttons in that mode.

To Set-Up:

- 1** Select the mode into which you want to program *Transport Control “Punch Through.”*
- 2** Press the corresponding *Device Button* and the *MUTE* button simultaneously. **SET** will appear in the LCD.
- 3** Press the *SELECT/PLAY* button. **PUNCH** will appear in the LCD.
- 4** Press either the *VCR Device Button* to set-up for VCR *Transport Control* or the *CD Device Button* to set-up for CD *Transport Control*. **VCR** or **CD** will flash in the LCD, depending on the *Device Button* selected.

Advanced Features

The *VCR or CD Transport Controls (PLAY, STOP, FAST FORWARD, REWIND, PAUSE, and RECORD)* will now override the original functions of the buttons in this mode.

To Return to the Original Setting:

- 1** Select the mode that you want to turn off the *Transport Control “Punch Through.”*
- 2** Press the corresponding *Device Button* and the *MUTE* button simultaneously. **SET** will appear in the LCD.
- 3** Press the *SELECT/PLAY* button. **PUNCH** will appear in the LCD.
- 4** Press the *Device Button* again. The **Device Mode** will flash in the LCD.

The *VCR or CD Transport Control “Punch Through”* feature is now turned off. The original functions assigned to these buttons are restored.

Using Your Remote

C. Changing the LCD Display

Twenty-seven different LCD displays can be selected for each Device mode of the remote control. To select an alternate LCD display, please use the following procedure:

- 1 Press and hold the Device button for which you would like to change the LCD setting.
- 2 While pressing the Device button, press and release the MENU button. Each time the MENU button is pressed, the LCD will show one of twenty-seven displays.
- 3 Release the Device button when you find the new LCD display you wish to assign to the Device mode.

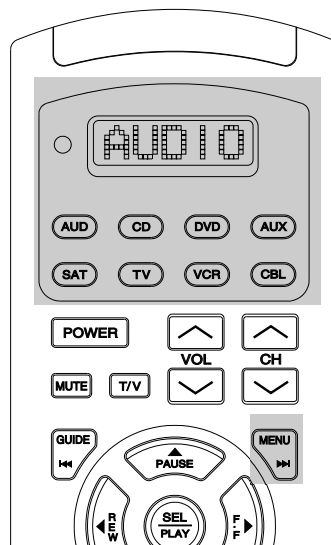

Choice of LCD Displays

TV	VCR	CABLE	SAT	AUDIO	CD
DVD	AUX	TV2	VCR2	TUNER	AMP1
AMP2	TAPE1	TAPE2	WEBTV	SURR	DAT
PROJE	AUX2	LD	AUD2	LIGHT	DSS
AV	TAPE	DAB			

Advanced Features

- 1** Press the *Audio Device Button* and the *MUTE* button simultaneously. **SET** will appear in the LCD.
- 2** Press *Memory Button M2*. **M2_ ##** will appear in the LCD.
- 3** Press the *MUTE ** button (to turn on the Audio receiver)
M2_01 will appear in the LCD.
Press the *TV Device Button* (to change to the TV mode)
M2_02 will appear in the LCD.
Press the *MUTE* button (to turn on the TV)
M2_03 will appear in the LCD.
Press the *VCR Device Button* (to change to the VCR mode)
M2_04 will appear in the LCD.
Press the *MUTE* button (to turn on the VCR)
M2_05 will appear in the LCD.
Press the *SAT Device Button* (to change to SAT mode)
M2_06 will appear in the LCD.
Press the *MUTE* button (to turn on the Satellite receiver)
M2_07 will appear in the LCD.

*Power On/Off is located on the MUTE button during the programming mode.
- 4** Press the *CHANNEL UP* button. **SAVE** will flash in the LCD, and the remote will return to the AUDIO mode.

Erasing Memory Buttons

- 1** Select the mode (AUD or SAT) in which you want to erase the *Memory Button*.
- 2** Press the corresponding *Device Button* (AUD or SAT) and *MUTE* button, simultaneously. **SET** will appear in the LCD. Press the *Memory Button* to be erased. **M(1-5)_# #** will appear in the LCD.
- 3** Press the *CHANNEL UP* button. **SAVE** will flash in the LCD. The *Memory Button* is now erased.

Note: Any previously stored commands on a **Memory Button** will be erased when new commands are stored on the same **Memory Button**.

Advanced Features

B: Memory Buttons

There are five memory buttons (M1~M4, Power) that are designed to store up to 15 commands in each button. Pressing any one of the memory button will send out the series of commands that are stored in the button.

You can either turn on or off up to eight devices by storing Power on/off commands or use it to select the favorite channels by storing channel numbers into the button. You can also combine Power on/off, select favorite channel and any of the features in the remote control to these buttons.

You can program any of the memory buttons (M1~M4, Power) in AUD mode and it will send out the stored commands in **Audio, CD, DVD and AUX modes**. You can also program the memory buttons in SAT mode and it will send out the stored commands in **Satellite, TV, VCR and CBL** modes.

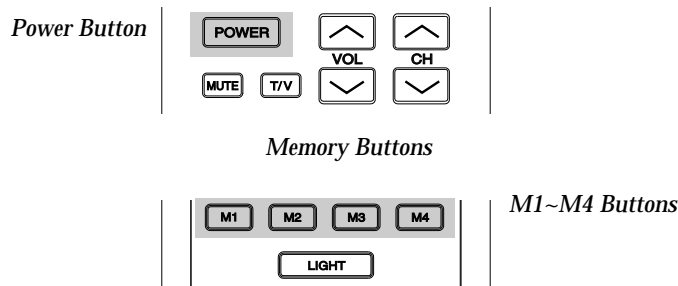

Advanced Features

- **Macro Commands:**

Memory Buttons can store and emit up to 15 commands including multiple Power On/Off sequences.

Example: In the Audio mode, the *POWER Memory Button* can be programmed to turn on the TV, turn on the Audio receiver, turn on the VCR and turn on the Satellite receiver with one button push.

Note: The *MUTE* button is used to designate *POWER* commands during *Memory Button* programming. See the *Example: Memory Button Programming* for further description.

- **Favorite Channels:**

Memory Buttons can provide direct access to your channels with one button push.

Example: In the SAT device mode each of the *Memory Buttons M1, M2, M3, M4* can provide direct access to a different satellite channel by sending out the three digit channel number for that channel to your satellite receiver with one button push.

Advanced Features

Programming Memory Buttons:

1 Select the section that you wish to program the *Memory Button* in by pressing the corresponding *Device Button* (AUD, or SAT) and *MUTE* button, simultaneously. **SET** will appear in the LCD.

2 Press one of the *Memory Buttons* (M1, M2, M3, M4, or POWER) into which you wish to store the functions. **M(1-5)_# #** will appear in the LCD.

3 Press in up to fifteen commands that you want stored in that Memory button. Each successive button selection will appear as **M(1-5)__(01-15)** in the LCD.

You can select functions from another mode by first pressing the corresponding *Device Button* and then the buttons where those functions are located in that mode. The pressing a *Device Button* also counts as one command.

Note: Each insertion of a *Device Button* adds a 1/2 second delay to the command sequence.

4 Press the *CHANNEL UP* button to store your selections. **SAVE** will flash three times in the LCD to confirm the programming.

Note: It can take up to 15 seconds to send out 15 commands from a memory button. Please continue to point the remote control at the device(s) until all the commands on the Memory Button have been sent out. This will ensure that all the commands are received by the device(s).

Example: Memory Button Programming.

To program *Memory Button M2* in the Audio mode to send the following commands: turn on the Audio receiver, turn on the TV, turn on the VCR, and turn on the satellite receiver.

Using Your Remote

No IR commands are emitted during the second press of a *Device button* when the remote is in the Automatic Audio mode. Pressing the *Device button* again will return the remote to the Main Device Mode.

To Delete the Automatic Audio for a *Device mode*:

- 1** Press and hold the AUDIO *Device button* and the LIGHT button simultaneously. **A_SET** will appear in the LCD.
- 2** Press the *Device button* corresponding to the *Device mode* to be deleted for Automatic Audio. E.g. VCR, CD etc. **A_OFF** will appear in the LCD indicating the deleted status of the automatic Audio mode for the *Device mode*.
- 3** Press the ENTER button to store the programming. **SAVE** will flash in the LCD and then return to **AUDIO**.

To Return to Automatic Audio for a *Device mode*:

- 1** Press and hold the AUDIO *Device button* and the LIGHT button simultaneously. **A_SET** will appear in the LCD.
- 2** Press the *Device button* corresponding to the *Device mode* to be added for Automatic Audio. E.g. VCR, CD etc. **A_ON** will appear in the LCD indicating the active status of the Automatic Audio mode for the *Device mode*.
- 3** Press ENTER to store the programming. **SAVE** will flash in the LCD and then return to **AUDIO**.

Backlighting

All the buttons and the LCD on the **SL-8000** are back-lit for 7 seconds when the *LIGHT* button is pressed. The back-light is extended an additional 7 seconds with any button press while the backlight is on.

Set-Up Code Tables

AUX

Manufacturer/Brand	Set-Up Code Number
3M	152
AIWA	015 071 100 114 164
ARCHER	155
AUTON	191
CARVER	006 008 027 024 036
DENON	105 227 229
DMX	156
DRAPER SCREEN	204
DWIN	080
EVERQUEST	206
EXTRON	151
FAROUDJA	184
FISHER	064
FUJI	209
GOLDSTAR	011
HARMAN KARDON	233
JERROLD	153
JVC	106 116 239 240 185
KENWOOD	005 013 023 026 064 145 146 181 190 185
LINN	124
LITE-TECH	208
LUTRON	158 159 077
LUXMAN	035 137 139
MAGNAVOX	027
MAKITA	186 201
MARANTZ	014 027 056 065 087
MCINTOSH	238
MINDPATH	205
MITSUBISHI	242 243
NAD	029 048
NAKAMICHI	244 245 025
NILES	160 187
NSM	161
ONKYO	002 012 016 017 018 019 115
OPTIMUS	026 054 055
PANASONIC	007 010 032 088 195
PHILIPS	027 087
PIONEER	003 039 047 050 066 098 222
POLKAUDIO	162
QUASAR	007 088
REPLAY	075

Set-Up Code Tables

Cable

Manufacturer/Brand	Set-Up Code Number
REGAL	049 050
REGENCY	057
SAMSUNG	030
SCIENTIFIC ATLANTA	003 011 041 042 043 045 046
SIGNAL	030
SIGNATURE	103
SL MARX	030
SONY	096
SPRUCER	047 078
STARCOM	002 004 008 009
STARGATE	008 030 097 104
TADIRAN	030
TOCOM	039 040 056
TOSHIBA	052
UNIKA	007 014
UNITED CABLE	004 053
UNIVERSAL	005 007 014 032 035
VIEWSTAR	012 015 018 086 087 088 089
ZENITH	052 060 093 100

Set-Up Code Tables

Cable

Manufacturer/Brand	Set-Up Code Number
ABC	103 003 004 039 042 046 053
AMERICAST	099
ANTRONIX	014
ARCHER	005 007 014
BELL SOUTH	099
CENTURION	092
CENTURY	007
CITIZEN	007
COMBANO	080 081
COMSAT	074
COMTRONICS	030
DIGICABLE	101
EAGLE	020 030 040
EASTERN	057 066
EHOSTAR	106
ELECTRICORD	032
GEMINI	008 054
GENERAL ELECTRIC	072
GENERAL INSTRUMENT	103 074 104
GNC	099
GOLDEN CHANNEL	030
HAMLIN	049 050 055
HITACHI	103 055
JERROLD	103 002 003 004 008 009 010 069 074
MAGNAVOX	010 012 064 079 095 094
MEMOREX	052
MITSUBISHI	102
M-NET	037
MOVIE TIME	028 032
NOVAPLEX	092
NSC	015 028 038 071
OAK	031 037 053
PANASONIC	044 047
PARAGON	052
PHILIPS	006 012 013 020 085 095
PIONEER	103 034 051 063 076 105
PRUCER	059
PTS	011 071 074
PULSAR	052
RCA	047
RECOTON	098

Set-Up Code Tables

VCR

Manufacturer/Brand	Set-Up Code Number
THOMAS	034
TMK	006
TOSHIBA	008 013 042 047 059 079 082 112 131 081
TOTEVISION	040 101
UNITECH	040
VECTOR RESEARCH	012
VICTOR	048
VIDEO CONCEPTS	012 034 046 141
VIDEOSONIC	040
WARDS	003 013 017 024 031 034 040 053 054 131
YAMAHA	012 034 039 043
ZENITH	034 048 056 058 072 080 101

Set-Up Code Tables

VCR

Manufacturer/Brand	Set-Up Code Number
mitsubishi	013 020 045 046 051 059 061 142 151 049
MTC	034 040
MULTITECH	024 034
NEC	012 023 039 043 048
NORDMENDE	043
OPTONICA	053 054
ORION	025
PANASONIC	066 070 083 133 140 145 157 163 074
PENTAX	013 020 031 063
PHILCO	031 034 067
PHILIPS	031 034 054 067 071 101
PILOT	101
PIONEER	013 021 048
PORTLAND	108
PULSAR	072
QUARTZ	002 014
QUASAR	066 145 075
RADIO SHACK	123
RCA	013 020 041 107 109 140 144 145 147 034 040 158
REALISTIC	003 008 010 014 031 034 040 053 054 101
RICO	058
RUNCO	148
SALORA	014
SAMSUNG	032 040 066 102 104 107 109 112 113 115 120 122 125
SANSUI	022 043 048 135
SANYO	003 007 010 014 134 102
SCOTT	017 037 112 129 131
SEARS	003 008 009 010 013 014 081 101 017 073 112
SHARP	031 054 149 159 165
SHINTOM	024
SIGNATURE	034
SONY	003 031 052 056 057 058 076 077 078 149 154
SOUNDESIGN	034
STS	013
SYLVANIA	031 034 059 067
SYMPHONIC	034
TANDY	010 034
TATUNG	039 043
TEAC	034 039 043
TECHNICS	031 070
TEKNIKA	019 031 034 101

Set-Up Code Tables

VCR

Manufacturer/Brand	Set-Up Code Number
AIWA	034 161
AKAI	016 043 046 124 125 142 146
AMPRO	072
ANAM	031
AUDIO DYNAMICS	012 023 039 043
BROOKSONIC	035 037 129
CANON	028 031
CAPEHART	108
CRAIG	003 040 135
CURTIS MATHES	031 041
DAEWOO	005 007 010 065 108 110 111 112 116 117 119
DAYTRON	108
DBX	012 023 039 043
DYNATECH	034 053
ELECTROHOME	059
EMERSON	006 017 025 027 029 031 034 035 036 037 046 101 129 131 138 153 162 116
FISHER	003 008 009 010
FUNAI	034
GE	031 063 072 107 109 144 147
GO VIDEO	132 136 155 040 115
GOLDSTAR	012 013 020 101 106 114 123
HARMAN KARDON	012 045
HITACHI	004 018 026 034 043 063 137 150 160 013
INSTANTREPLAY	031
JCL	031
JCPENNY	012 013 015 040 066 101
JENSEN	043
JVC	012 031 043 048 050 055 060 130 150 152
KENWOOD	014 048 034 047
LLOYD	034
LXI	003 009 017 034 106
MAGIN	040
MAGNAVOX	031 034 041 067 068 156 164
MARANTZ	012 031 067 069
MARTA	101
MATSUI	027 030
MEI	031
MEMOREX	003 010 014 031 034 053 072 101 102 134 139
MGA	045 046 059
MINOLTA	013 020

Set-Up Code Tables

TV

Manufacturer/Brand	Set-Up Code Number
SAMPO	197 058 004
SAMSUNG	004 050 089 101 105 127 143 160
SANYO	166 007 020 053 057 082 187
SCOTT	004 028 043 048 143
SEARS	015 030 004 007 028 057 143 094 160 082 165 166
SELECO	189
SHARP	170 081 019 028 029 014 004 022 143 175
SIEMENS	088
SIGNATURE	072
SONY	070 085 139 147 126 185 194
SOUNDESIGN	004 028 003 043
SPECTRICON	112
SSS	004 043
SUPRE MACY	002
SYLVANIA	197 003 059 060 063 064 164 044 160 127
TANDY	081
TATUNG	056 062
TECHNICS	034 080
TECHWOOD	004
TEKNIKA	002 003 004 024 028 043 072 101 143
TELEFUNKEN	037 046 086 087
TELERENT	072
TERA	172
TMK	004
TOSHIBA	007 015 030 040 062 101 138
TOTEVISION	143
UNIVERSAL	008 009
VIDEO CONCEPTS	146
VIDIKRON	174 184 188 192
VIDTECH	004
WARDS	004 008 009 019 028 060 061 063 064 072 074 143 164
	034
WESTING HOUSE	076
YAMAHA	197 004
YORK	004
YUPITERU	043
ZENITH	072 073 095 103 157
ZONDA	112

Set-Up Code Tables

TV

Manufacturer/Brand	Set-Up Code Number
JCPENNY	197 004 008 009 024 030 065 101 143 156 160
JENSEN	013
JVC	034 038 070 083 145 199
KEC	043
KENWOOD	197 070
KLOSS	002 059
KMC	143
KTV	197 043 143 154
LODGENET	072
LOGIK	072
LUXMAN	004
LXI	166 007 015 052 081 160 164
MAGNAVOX	197 003 004 022 059 060 061 063 064 127 160 164 094
MARANTZ	197 164
MATSUI	164
MEMOREX	007 072 004
METZ	088
MGA	197 004 024 028 042
MINERVA	088
MITSUBISHI	004 024 028 040 042 109 124 146 191
MTC	197 004 062 101
NAD	015 025
NEC	132 130 134 197 040 016 024 056 019
NIKEI	043
ONKING	043
ONWA	043
OPTONICA	019 081
ORION	096
PANASONIC	034 056 080 092 164
PHILCO	197 003 024 056 059 060 063 064 164 004
PHILIPS	197 003 004 005 038 059 093 164 127
PIONEER	197 018 023 025 116 135 190
PORTLAND	004 143
PROSCAN	144 160 161 165 167
PROTON	004 058 131 143 171 173 193
QUASAR	034 056 092
RADIO SHACK	019 043 143 004 127
RCA	160 161 165 065 156 144 197 004 023 024 056 074 152
REALISTIC	007 019 043 047
ROCTEC	186
RUNCO	168 169 178 179 180 181 182 183

Set-Up Code Tables

TV

Manufacturer/Brand	Set-Up Code Number
ADMIRAL	072 081 161 160
AKAI	197 146
AMARK	112 143
AMPRO	073 167
AMSTRAD	052
ANAM	043 054 056 080 112 131
AOC	197 004 112 058
AUDIOVOX	076
BLAUPUNKT	088
CANDLE	197 002 003 004
CAPEHART	058
CETRONIC	043
CITIZEN	197 002 003 004 043 101 103 143
CLASSIC	043
CONCERTO	004
CONTEC	043 050 051
CORONADO	143
CRAIG	043 054
CROWN	043 143
CURTIS MATHES	197 101 004 143
CXC	043
DAEWOO	004 016 043 044 076 103 114 125 127 143
DAYTRON	004 143
DWIN	177
DYNASTY	043
DYNATECH	062
EIKI	187
ELECTROHOME	024 076 143 196
EMERSON	197 004 005 028 043 047 048 050 051 076 096 143 151 153 154 155
FISHER	007 057
FUJITSU	198
FUNAI	028 043
FUTURETECH	043
GE	197 008 009 034 056 073 074 130 144 155 160 161 165 004 091
GOLDSTAR	004 102 106 112 113 116 119 127 143
HALL MARK	004
HITACHI	004 009 010 011 012 023 075 143 158 163 166 072
INFINITY	164
JBL	164

Set-Up Code Tables

Satellite

Manufacturer/Brand	Set-Up Code Number
PROSAT	072
PROSCAN	151 106 150
RCA	151 106 150
REALISTIC	043 074
SAMSUNG	123
SATELLITE SERVICE	028 035 047 085
SONY	103
STARCAST	041
SUPERGUIDE	020 124 125
TEECOM	023 026 075 087 088 090 107 130 137
TOSHIBA	002 127
TOWN & COUNTRY	023 026
UNIDEN	016 025 042 043 044 045 048 049 078 079 080 086 101 135 136
VIEWSTAR	115
WINEGARD	128 146
ZENITH	081 082 083 084 091 120

Set-Up Code Tables

Satellite

Manufacturer/Brand	Set-Up Code Number
ALPHASTAR	123
AMPLICA	050
BIRDVIEW	129 113 051 126
BSR	053
CAPETRONICS	053
CHANNEL MASTER	013 014 015 018 036 055
CHAPARRAL	008 009 012 077
CITOH	054
CURTIS MATHES	050
DRAKE	005 006 007 010 011 112 116 141 052
DX ANTENNA	024 046 056 076
ECHOSTAR	038 040 057 058 093 094 095 096 097 098 099 100 122
ELECTROHOME	089
EUROSAT	114
FUJITSU	017 021 022 027 133 134
GENERAL ELECTRIC	151 106 150
GENERAL INSTRUMENT	003 004 016 029 031 059 101 148
HITACHI	139 140
HOME CABLE	080 044 029
HOUSTON TRACKER	033 037 039 104 057 051
HUGHES	068
HYTEK	053
HYUNDAI	149
ICR	023
JANIEL	060 147
KATHREIN	108
LEGEND	057
LUTRON	132
LUXOR	144 062
MACOM	010 059 063 064 065
MEMOREX	057
NEXTWAVE	028 124 125
NORSAT	069 070
PACE	143
PANASONIC	142 060
PANSAT	121
PERSONAL CABLE	117
PHILIPS	071
PL	023 026
PRESIDENT	019 102
PRIMESTAR	110 030

Set-Up Code Tables

Audio

Manufacturer/Brand	Set-Up Code Number
ADC	007
ADCOM	082 092 225 161 269
AIWA	018 104 170 202 203 213 211 188
AKAI	138 189
AMC	125 126 127 128 258
AMEND	054
AMX	196
ANGSTROM	142
ARCAM	141
AUDIO ACCESS	147
AUDIO ALCHEMY	135
AUDIO DESIGN	194 221 011
AUDIO EASE	021 196 207
AUDIO FILE	071
AUDIO MATRIX	167
AUDIO SOURCE	273
AUDIO TECHNICA	134
B & K	096 097
BOSE	070 170 224
BRYSTON	023
CARVER	006 028 061 071 201 214 226 180 185 022 029 077
CASIO	076
CHIRO	140
CINEMA SOUND	034 134
CITATION	148 272
CLARION	026
CURTIS MATHES	076
DENON	002 034 109 215 229 230 027 037 234 259
EIGER	149
ELAN	057
ENLIGHTENED AUDIO	099 098
FISHER	047 214 180 182
FOSGATE	062 231
GE	056 260
GOLDSTAR	008
HAFLER	174
HARMAN KARDON	231 233 254 153 154 118 121 227
HITACHI	020
INKEL	197
JBL	263
JCPENNY	076 216

Set-Up Code Tables

Audio

Manufacturer/Brand	Set-Up Code Number
JEFF ROWLAND	206
JENSEN	058
JVC	240 163 191 114 266
KENWOOD	026 066 145 146 181 190 197 192 182 199 151 222 180 005
KINERGETICS	220
KOSS	216
KRELL	150 072
KYOCERA	007
LEXICON	120 235 236 237
LINN	124
LUXMAN	137 139 052 165 115 004 009
LXI	076 056
MAGNAVOX	086 164 152 208
MARANTZ	006 028 031 040 063 185 186 251 265
MCINTOSH	238
MCS	076
MERIDIAN	100 012 013
MITSUBISHI	242 243 204
MONDIAL	157 158 042 043 081 112
NAD	186 113
NAKAMICHI	111 244 245 172 183
NEC	176
ONKYO	017 046 064 107 108 187 079 080 090 179 209 270
OPTIMUS	026 041 138
PANASONIC	032 195 219 177
PARASOUND	129 130 132 261
PHAST	196
PHILIPS	249 250 251 063
PIONEER	014 033 039 044 045 050 069 159 168 116 035 078 198
PROCEED	144 268
RCA	010 048 117 156 067
REALISTIC	019 056 073 075 095
REVOX	162
ROTEL	074 083 085
SAMSUNG	016
SANSUI	040 048 110 119 065 228
SANYO	047 059
SCOTT	019 091
SEARS	076
SHARP	026 094 131 175 181

Set-Up Code Tables

CD

Manufacturer/Brand	Set-Up Code Number
ADCOM	062 042
AIWA	059 065 088 089 105 122 170 187
AKAI	085 195 202
AMC	231 232
AMEND	118
ARCAM	238
AUDIO ACCESS	119 147
AUDIO EASE	165
AUDIO TECHNICA	046
BSR	037 057
CALIFORNIA AUDIO	103 008
CAPETRONIC	063
CARRERA	057 080
CARVER	185 041 044 050 086 107 130 134 135 138 139 203 204 167
CASIO	111 182
CLARINETTE	182
CREEK	159
CROWN	035
DENON	002 123
EMERSON	042 069 102
FISHER	050 185 134 008
FRABA	111
GENEXXA	010 069 102
GOLDSTAR	080
HAITAI	093
HARMAN KARDON	018 033 047 208
HITACHI	042 175
INKEL	130 143 144
JC PENNY	014 061 092 141
JENSEN	158
JVC	004 022 136 163 213 214 242
KENWOOD	185 007 023 055 071 072 142 137
KOSS	061
KRELL	241
KYOCERA	005
LOTTE	102
LUXMAN	011 028 070 076
LXI	059
MAGNAVOX	044 107
MARANTZ	027 041 044 051 077 107 209
MCINTOSH	212
MCS	014 073 092
MEMOREX	010
MISSION	044 107
MINISUBISHI	179

Set-Up Code Tables

CD

Manufacturer/Brand	Set-Up Code Number
MITSUMI	153
MODULAIRE	182
MONDIAL	147
NAD	006 005 067 178
NAKAMICHI	217 218 219 095
NEC	014 062
NIKKO	046
NSM	044 107
ONKYO	030 038 039 168 169
OPTIMUS	010 050 057 058 081 082 083 085 093 195
PANASONIC	103 201 172 008 068
PARASOUND	233
PHILIPS	041 044
PIONEER	010 020 025 056 174 175 176
PROCEED	239
PROTON	044 107 228
QUASAR	103 008
RADIO SHACK	182
RCA	017 042 150
REALISTIC	042 050 051 102 181 182 187
ROTEL	044 107 161 178
SAE	044 107
SANSUI	044 069 107 128 171 190 125
SANYO	050
SCOTT	069 102
SHARP	026 031 051 066
SHERWOOD	003 019 051 096 112 115 119 166
SIGNATURE	033
SONY	048 081 097 126 133 177 225 226 164
SOUNDESIGN	251
SUMO	155
SYLVANIA	044 107
SYMPHONIC	052 181
TAEKWANG	195 085
TANDY	010
TEAC	015 034 036 051 052 101 131 140 079
TECHNICS	060 103 200 172 184 008 068
TECHWOOD	076
THETA DIGITAL	234 235
TOSHIBA	006 067 091 160 148
VECTOR RESEARCH	080
VICTOR	004 022 114 124
WARDS	185 033
YAMAHA	024 046 054 186 183
YORX	182

Set-Up Code Tables

AUX

Manufacturer/Brand	Set-Up Code Number
RUSSOUND	081
SANSUI	027 113 119 224
SCIENTIFIC ATLANTA	163 156
SHARP	026 057 131 175 181
SHERWOOD	038 004 028 030 033 034
SIMA	082
SOLO ELECTRONICS	207
SOMFY	078 079
SONY	020 022 052 084 089 164 165 166
STARCOM	153
TEAC	009 059 212
TECHNICS	007 010 076 088 109 122 193
TOSHIBA	112
TURBOSCAN	167
VELODYNE	203
VICTOR	106
X-10	183
XANTECH	168 169 170 171 172 188 189
YAMAHA	021 026 031 067

Set-Up Code Tables

DVD

Manufacturer/Brand	Set-Up Code Number
DENON	007 206 207 080
FUNAI	120
GE	026 027
GOLDSTAR	057
JVC	012
KENWOOD	152 013
MAGNAVOX	066 032 121
MARANTZ	211
MITSUBISHI	017 121
NAD	121
ONKYO	076 035
OPTIMUS	049 013
PANASONIC	021 113 042
PHILIPS	066 032
PIONEER	023 106 117 121
PROSCAN	026 027
RADIO SHACK	120
RCA	026 027 002
REALISTIC	049
RUNCO	127
SAMSUNG	056 070
SANYO	075
SHARP	152 013
SONY	033 053 110
TECHNICS	113
THETA DIGITAL	032
THOMPSON	026 027
TOSHIBA	035 152 106
YAMAHA	042 129 043
ZENITH	057 074

Set-Up Code Tables

Audio

Manufacturer/Brand	Set-Up Code Number
SHERWOOD	024 038 055 102 103 105 106 051 030
SONY	018 093 223 247 248 160 166 015 101 184 218 271
SOUNDESIGN	036
SOUNDSTREAM	084 088
SSI	068
SUMO	171
TAEKWANG	138
TEAC	005 019 049 111 212 217
TECHNICS	122 176 193 219 178 177 200 257 262
THETA DIGITAL	136
TOSHIBA	060 087 198
WARDS	180
YAMAHA	026 253 169 067 173 205 264 232 089 264
ZENITH	143 210

ØEE-0031V
Rev. 1